



**SAMEC**

ESTOFADOS

## NOSSA EMPRESA

Fundada em abril de 1993, a samec - industria e comércio de móveis iniciou seus trabalhos em um barracão alugado. Três anos mais tarde, em 1996, instalou-se em sede própria, na rua 14 de outubro, em Sarandi - Pr, em uma área de 5.000(m2) metros quadrados.

A samec móveis trabalha na fabricação de estofados com ótima qualidade e requinte na arte de decorar ambientes.

Há 27 anos no mercado, buscamos sempre a qualidade dos nossos produtos e a satisfação de nossos clientes, aliando um rigoroso controle de qualidade e acabamento, visando sempre atender os mais diversos públicos.



**ACESSE:**

[www.samecmoveis.com.br](http://www.samecmoveis.com.br)

MODELO

1006





1

Encosto reclinável, almofadas soltas de espuma soft

2

Assento retrátil com molas espiral e percinta elástica

3

Madeira de eucalipto

**MODELO  
1006**

Visão Frontal

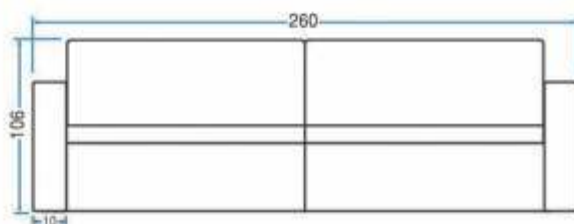

Visão Superior (Retrátil Aberto)



Visão Lateral

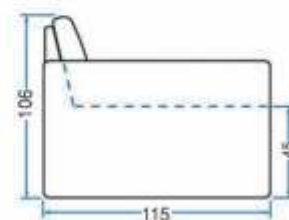

Comprimento	260 cm
Prof. retrátil fechado	115 cm
Prof. retrátil aberto	170 cm
Altura c/ rolinho	106 cm
Altura s/ rolinho	96 cm
Braço	10 cm
Módulo	120 cm



MODELO

1011





1

Sofá cama, almofadas soltas com fibra siliconada

2

Assento com molas espiral, acompanha as almofadas decorativas

3

Madeira de eucalipto

**MODELO  
1011**

Visão Frontal

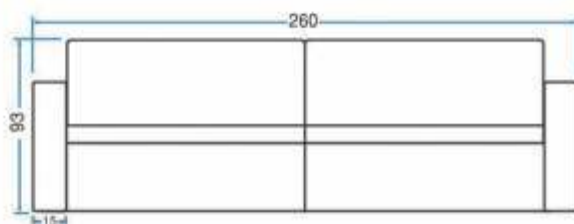

Visão Superior (Reclat Aberto)



Visão Lateral

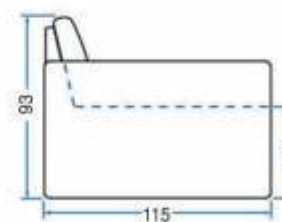

Comprimento	260 cm
Prof. retrátil fechado	115 cm
Prof. retrátil aberto	160 cm
Altura	93 cm
Altura do assento	45 cm
Braço	15 cm
Módulo	115 cm



MODELO

1021





1

Sofá cama, almofadas soltas com fibra siliconada

2

Assento com molas espiral

3

Madeira de eucalipto

MODELO  
**1021**

Visão Frontal

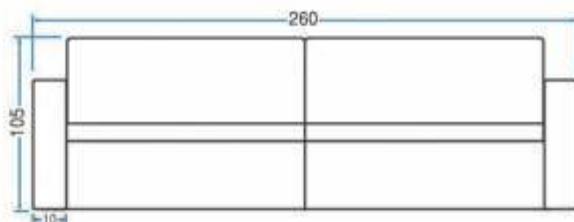

Visão Superior (Retrátil Aberto)

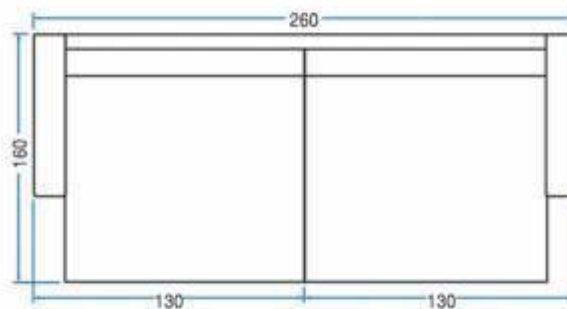

Visão Lateral

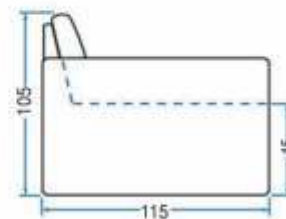

Comprimento	260 cm
Prof. retrátil fechado	115 cm
Prof. retrátil aberto	160 cm
Altura	105 cm
Altura do assento	45 cm
Braço	10 cm
Módulo	120 cm



MODELO

1022







1

Encosto reclinável  
com fibra siliconada

2

Assento retrátil com molas ensacadas  
dentro do pillow de espuma

3

Madeira de eucalipto  
Cinta e fivela na frente do braço opcional

MODELO  
**1022**

Visão Frontal

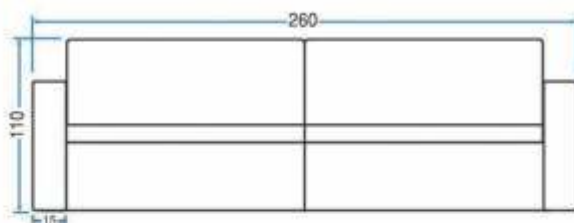

Visão Superior (Retrátil Aberto)



mola ensacada

Visão Lateral

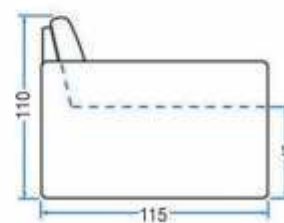

Comprimento	260 cm
Prof. retrátil fechado	115 cm
Prof. retrátil aberto	170 cm
Altura	110 cm
Altura do assento	45 cm
Braço	15 cm
Módulo	115 cm

MODELO

1015





1

Encosto reclinável e  
desmontável com fibra siliconada

2

Assento retrátil com mola - Espuma D26  
e percintas elásticas

3

Pés vão com  
embalagens separadas

MODELO  
1015

Visão Frontal

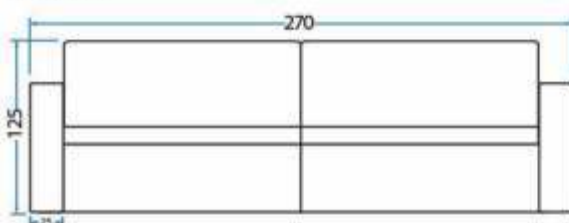

Visão Superior (Retrátil Aberto)



Visão Lateral

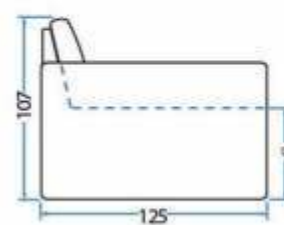

Comprimento	-	270 cm
Prof. retrátil fechado	-	115 cm
Prof. retrátil aberto	-	170 cm
Altura	-	107 cm
Altura do assento	-	45 cm
Braço	-	25 cm
Módulo	-	110 cm



MODELO

2025





1

Encosto reclinável e desmontável com fibra siliconada

2

Assento retrátil com mola  
Espuma D26 - Madeira eucalipto

3

Percinta Elástica e mola espiral

## MODELO 2025

Comprimento	270 cm		Braço	25 cm
Módulo com braço	135 cm		Módulo sem braço	110 cm
Retrátil fechado	115 cm		Retrátil aberto	170 cm
			Altura	105 cm

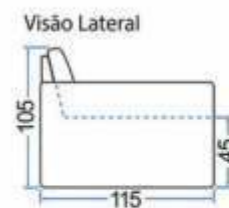
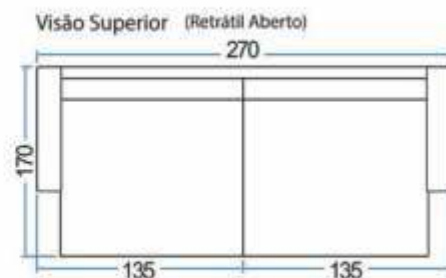
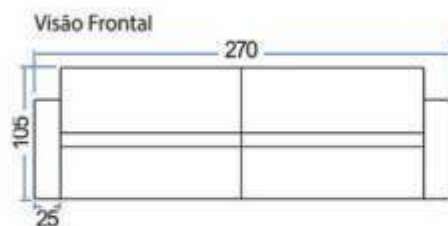



MODELO

2070





MODELO  
2070

1

Encosto reclinável e desmontável com fibra selecionada

2

Assento com fibra selecionada e mola

3

Madeira Eucalipto

Comprimento	290 cm
Profundidade	115 cm
Retrátil aberto	170 cm
Braço	25 cm
Assento	120 cm
Altura	110 cm

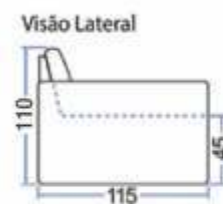
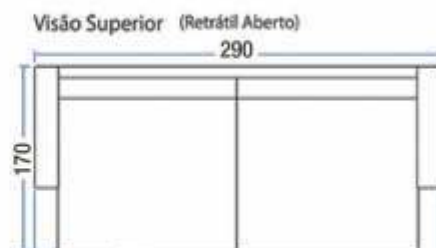
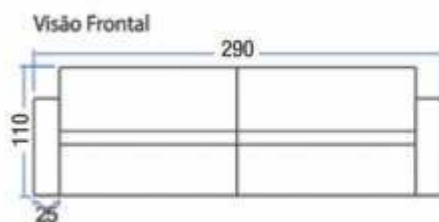



MODELO

2075





1

Encosto reclinável e desmontável com fibra siliconada

2

Assento retrátil com mola espuma D28 soft

3

Madeira eucalipto

MODELO  
2075

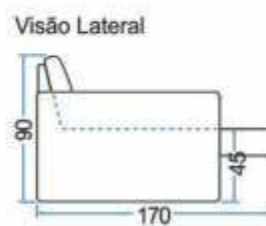
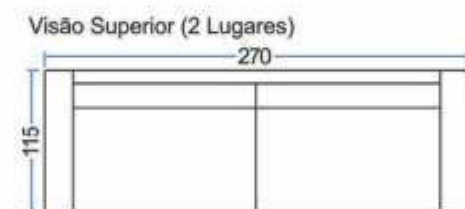
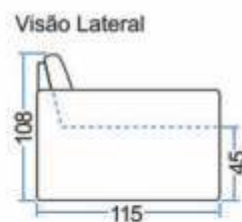
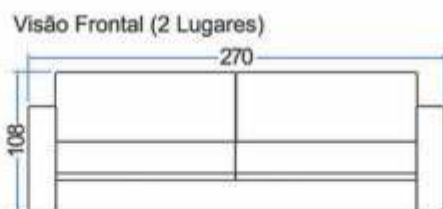

Altura	108 cm
Comprimento 2L	270 cm
Prof. aberto	170 cm
Profundidade	115 cm



MODELO

2080







MODELO  
2080

- 1 Encosto reclinável e desmontável com fibra selecionada
- 2 Assento retrátil com mola espiral e persinta elástica
- 3 Madeira Eucalipto



costura dupla

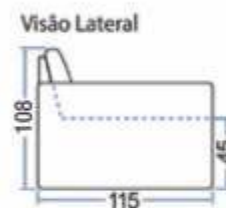
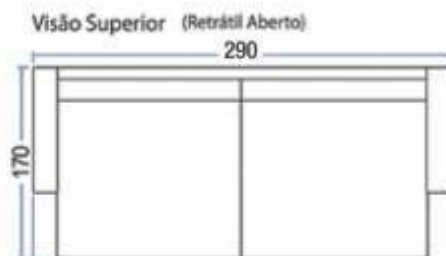
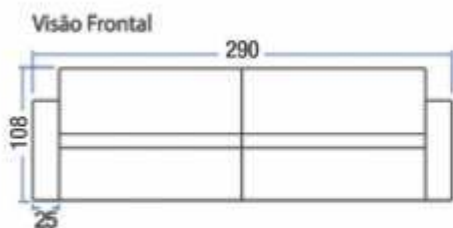

Comprimento	290 cm
Profundidade	115 cm
Retrátil aberto	170 cm
Braço	25 cm
Assento	110 cm
Altura	108 cm

MODELO

2095





1

Encosto reclinável e desmontável com fibra siliconada

2

Assento retrátil com mola Espuma D26 - Madeira eucalipto

3

Percinta Elástica e mola espiral / Madeira eucalipto

**MODELO  
2095**

Comprimento	270 cm		Braço	25 cm
Módulo com braço	135 cm		Módulo sem braço	110 cm
Retrátil fechado	115 cm		Retrátil aberto	170 cm
			Altura	105 cm

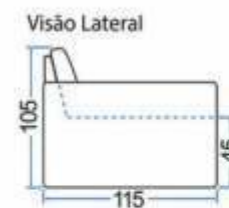
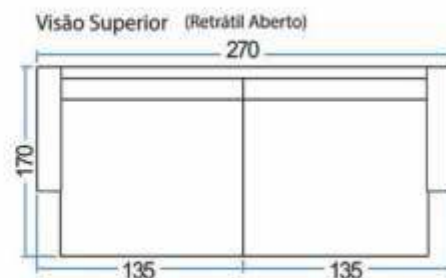
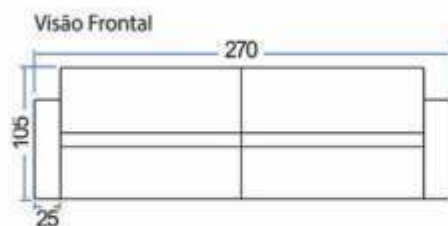



MODELO

3005





1

Encosto com espuma Soft

2

Assento retrátil com mola e espuma D26

3

Madeira eucalipto

**MODELO  
3005**

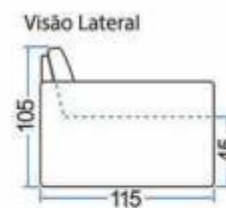
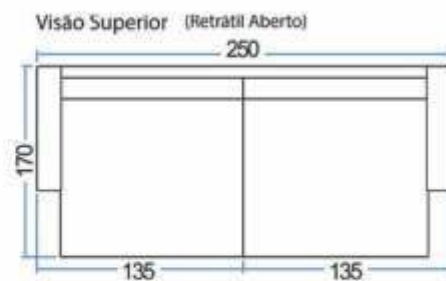
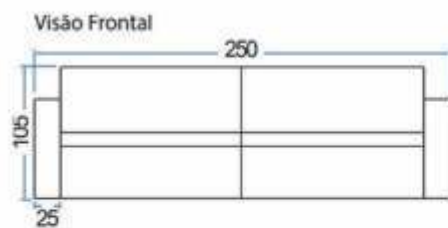

Comprimento	.	250 cm
Prof. retrátil fechado	.	115 cm
Prof. retrátil aberto	.	170 cm
Altura	.	105 cm
Altura do assento	.	45 cm
Largura do braço	.	25 cm



MODELO

3015 Eletrônico





MODELO  
**3015**  
Eletrônico

- 1 Encosto reclinável com fibra siliconada
- 2 Assento retrátil com mola e espuma D26
- 3 Madeira eucalipto

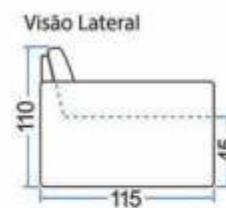
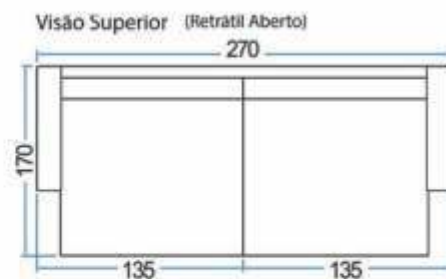
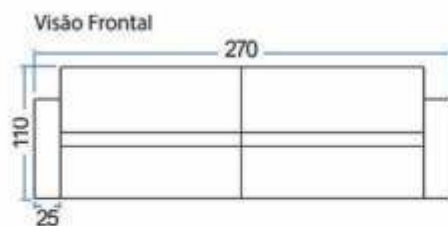

Comprimento	.	270 cm
Prof. retrátil fechado	.	115 cm
Prof. retrátil aberto	.	170 cm
Altura	.	110 cm
Altura do assento	.	45 cm
Largura do braço	.	25 cm



MODELO

3065







1

Encosto reclinável  
com fibra siliconada

2

Assento retrátil com mola  
com espuma D26

3

Madeira  
eucalipto

MODELO  
**3065**  
ELETRÔNICO

Comprimento	.	270 cm
Prof. retrátil fechado	.	120 cm
Prof. retrátil aberto	.	165 cm
Altura	.	100 cm
Altura do assento	.	45 cm
Largura do braço	.	25 cm

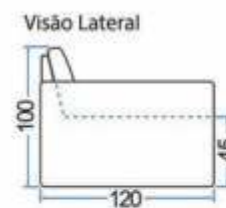
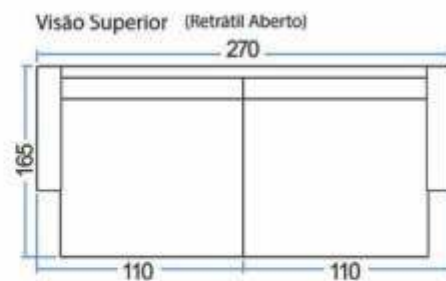
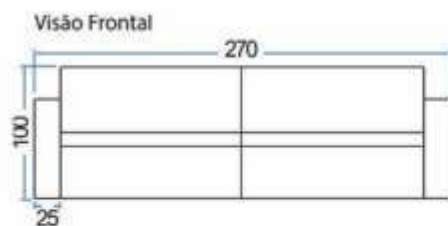

MODELO

4015





1

Encosto reclinável  
com almofada solta

2

Assento retrátil com mola  
com espuma D26

3

Madeira  
eucalipto

MODELO  
**4015**

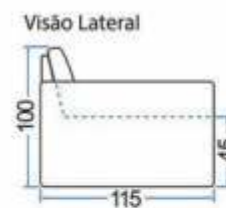
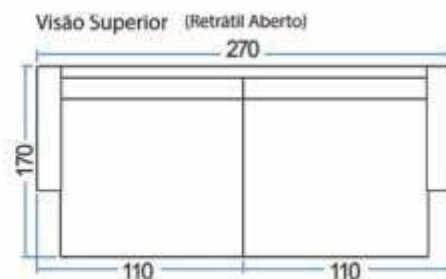
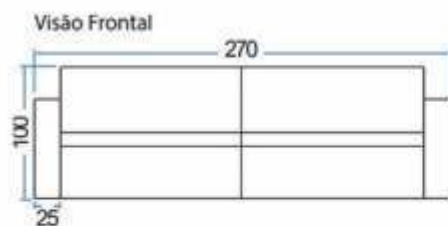

Comprimento	.	270 cm
Prof. retrátil fechado	.	115 cm
Prof. retrátil aberto	.	170 cm
Altura	.	100 cm
Altura do assento	.	45 cm
Largura do braço	.	25 cm



MODELO

4030





1

Encosto reclinável  
com fibra siliconada

2

Assento retrátil com mola  
com espuma D26

3

Madeira  
eucalipto

MODELO  
**4030**

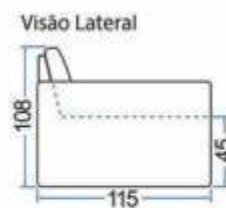
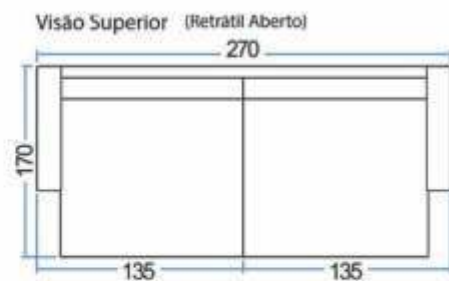
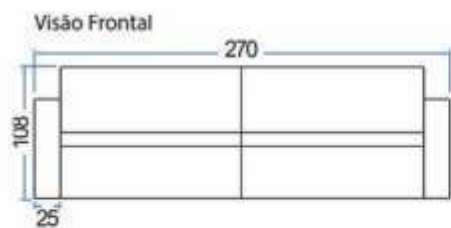

Comprimento	270 cm
Prof. retrátil fechado	115 cm
Prof. retrátil aberto	170 cm
Altura	110 cm
Altura do assento	45 cm
Largura do braço	25 cm



MODELO

5015







1

Encosto reclinável  
com fibra siliconada

2

Assento retrátil com mola  
com espuma D26

3

Madeira  
eucalipto

**MODELO  
5015**

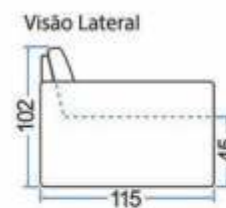
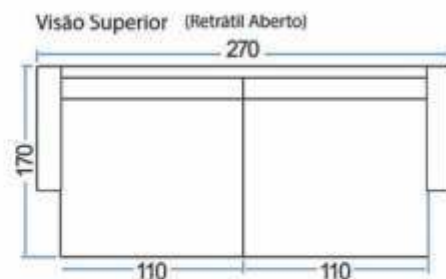
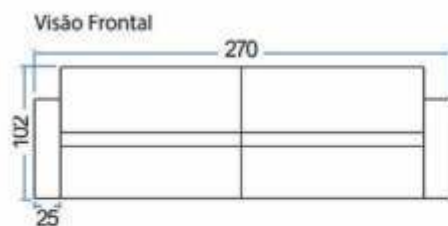

Comprimento	.	270 cm
Prof. retrátil fechado	.	115 cm
Prof. retrátil aberto	.	170 cm
Altura	.	102 cm
Altura do assento	.	45 cm
Largura do braço	.	25 cm

MODELO

5045





MODELO  
5045

- 1 Almofadas soltas com fibra siliconada
- 2 Assento retrátil com mola Espuma D26 - Madeira eucalipto
- 3 Percinta Elástica e mola espiral

Visão Frontal (2 Lugares)

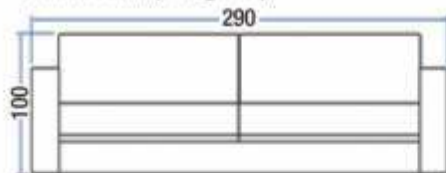

Visão Lateral

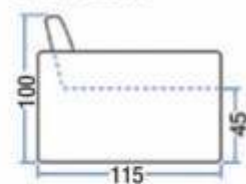

Visão Superior (2 Lugares)

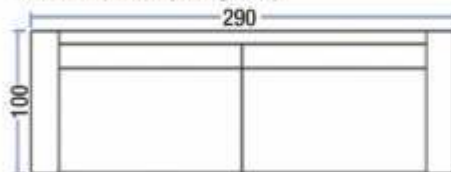

Visão Lateral



Comprimento	270 cm
Altura	100 cm
Profundidade	115 cm
Profundidade Aberta	170 cm
Braço	10 cm



MODELO

6025





1

Reclinável com fibra ciliconada  
Puff Baú

2

Assento retrátil  
Espuma D26 - Madeira eucalipto

3

Percinta elástica

MODELO  
6025 /

Comprimento:	2,70 m		Braço:	0,25 m
Retrátil fechado:	1,70 m		Módulo sem braço:	1,10 m
Altura do assento	0,45 m		Retrátil aberto:	1,70 m
			Altura:	1,13 m

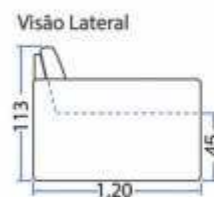
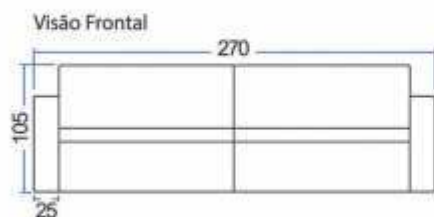

MODELO

6035







1

Reclinável espuma soft

2

Assento retrátil com molas  
Espuma D26 - Madeira eucalipto

3

Percinta elástica e mola espiral  
Acompanha 6 almofadas decorativa

## MODELO 6035 /

Comprimento:	2,40 m		Braço:	0,10 m
Retrátil fechado:	1,60 m		Módulo sem braço:	1,10 m
Altura do assento	0,45 m		Retrátil aberto:	1,70 m
Altura com encosto abaixado	0,76 m		Altura:	1,09 m

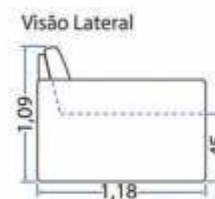
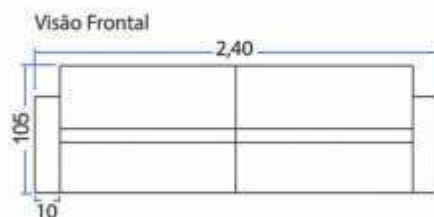

MODELO

7010





- 1
- 2
- 3

Encosto reclinável  
com fibra siliconada

Assento retrátil com molas  
Percintas elásticas e espuma D26

Madeira  
eucalipto

MODELO  
**7010**

Visão Lateral

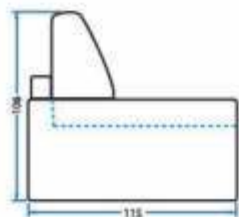

Visão Frontal

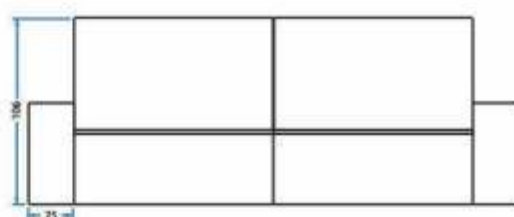

Visão Superior (Retrátil Fechado)



Visão Superior (Retrátil Aberto)

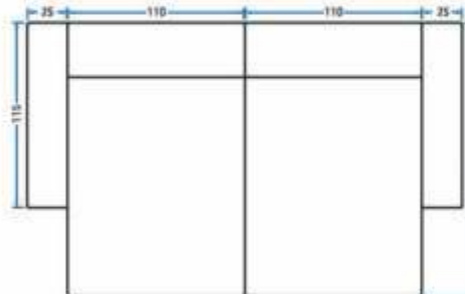

Comprimento	:	270 cm
Prof. retrátil fechado	:	115 cm
Prof. retrátil aberto	:	170 cm
Altura	:	106 cm
Largura do braço	:	25 cm
Largura do módulo	:	110 cm



MODELO

7015





MODELO  
7015

- 1 Almofadas soltas com fibra siliconada
- 2 Assento retrátil com mola  
Espuma D26 - Madeira eucalipto
- 3 Percinta Elástica e mola espiral

Visão Frontal (2 Lugares)

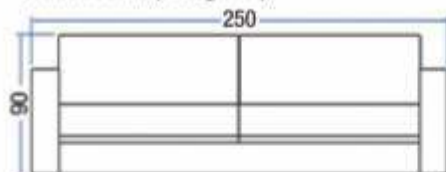

Visão Lateral

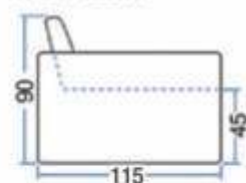

Visão Superior (2 Lugares)

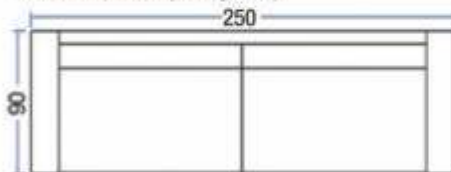

Visão Lateral



Comprimento	250 cm
Braço	15 cm
Módulo sem braço	110 cm
Altura	90 cm
Retrátil aberto	160 cm
Profundidade	115 cm

Cinto da lateral do braço opcional



MODELO

7016







- 1 Encosto eletrônico
- 2 Percina elástica, madeira de eucalipto
- 3 Acompanha 4 almofadas

**MODELO  
7016**

Visão Frontal

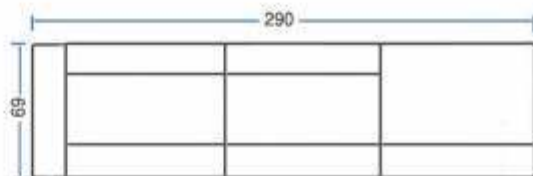

Visão Superior

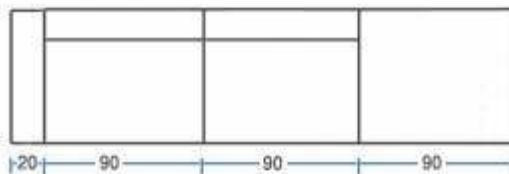

Visão Lateral

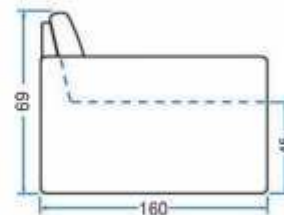

Comprimento	290 cm
Profundidade	160 cm
Altura	69 cm
Altura do encosto	27 cm
Altura do assento	42 cm
Largura do encosto	25 cm
Largura do braço	20 cm

MODELO

7020





1

Encosto reclinável  
com fibra siliconada

2

Assento retrátil com molas  
Percintas elásticas e espuma D26

3

Madeira  
eucalipto

MODELO  
**7020**

Visão Lateral

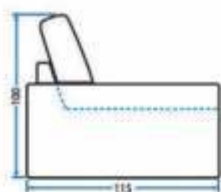

Visão Frontal

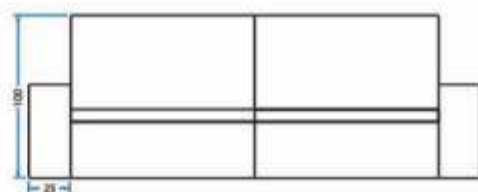

Visão Superior (Retrátil fechado)



Visão Superior (Retrátil aberto)

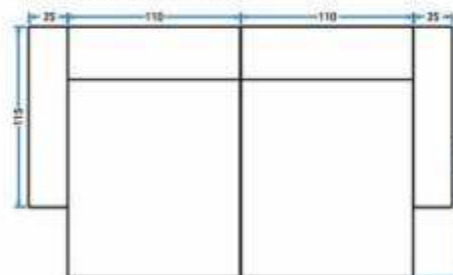

Comprimento	.	270 cm
Prof. retrátil fechado	.	115 cm
Prof. retrátil aberto	.	170 cm
Altura	.	100 cm
Largura do braço	.	25 cm
Largura do módulo	.	110 cm



MODELO

7025





MODELO  
7025

- 1 Almofadas soltas com fibra siliconada
- 2 Assento retrátil com mola  
Espuma D26 - Madeira eucalipto
- 3 Percinta Elástica e mola espiral

Visão Frontal (2 Lugares)

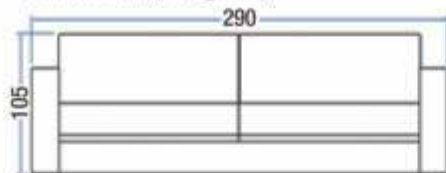

Visão Lateral

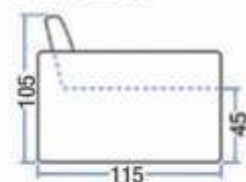

Visão Superior (2 Lugares)

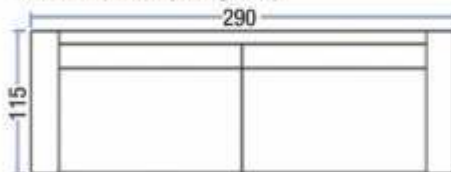

Visão Lateral



Comprimento	290 cm
Braço	25 cm
Módulo sem braço	120 cm
Altura	92 cm
Retrátil aberto	160 cm
Profundidade	115 cm
Caixa traseira	8 cm



MODELO

8020







1

Encosto reclinável  
com fibra siliconada

2

Assento retrátil com molas  
Percintas elásticas e espuma D26

3

Madeira  
eucalipto

MODELO  
**8020**

Visão Lateral

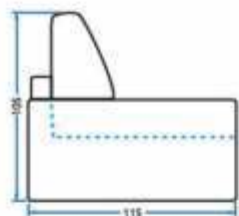

Visão Frontal

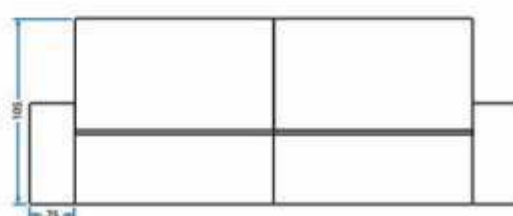

Visão Superior (Retrátil Fechado)

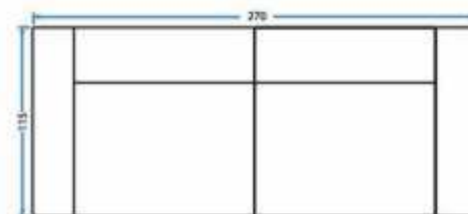

Visão Superior (Retrátil Aberto)

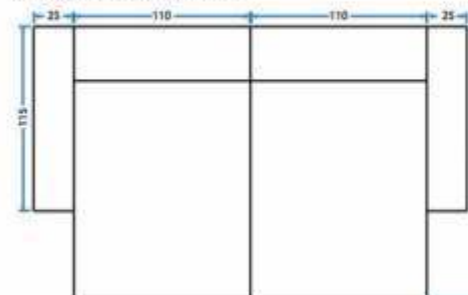

Comprimento	.	270 cm
Prof. retrátil fechado	.	115 cm
Prof. retrátil aberto	.	170 cm
Altura	.	105 cm
Largura do braço	.	25 cm
Comprimento da chaise	.	110 cm

MODELO

8035 MOLA ENSACADA





MODELO  
8035



mola ensacada

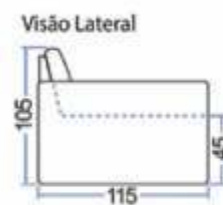
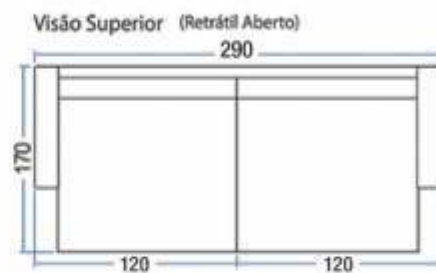
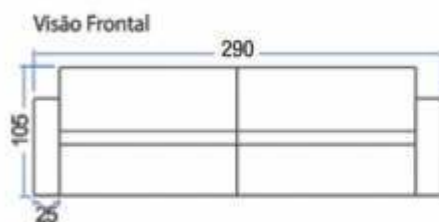

1

Encosto reclinável e desmontável  
com fibra siliconada

2

Assento com mola ensacada  
com espuma D26

3

Percinta Elástica e  
mola espiral

Comprimento	290 cm
Braço	25 cm
Módulo sem braço	120 cm
Altura	105 cm
Retrátil aberto	170 cm
Profundidade	115 cm



MODELO

**8055** MOLA ENSACADA





MODELO  
8055



mola ensacada

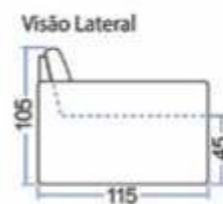
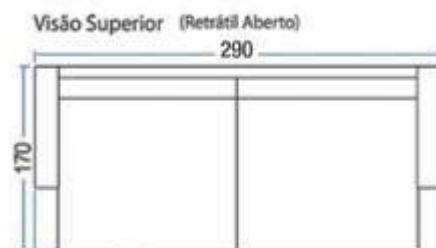
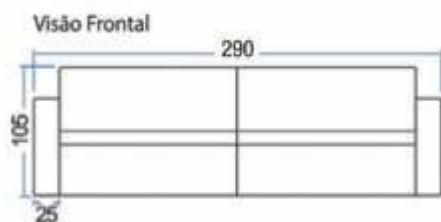

- 1 Encosto reclinável com espuma soft
- 2 Assento retrátil com mola Espuma D26 - Madeira eucalipto
- 3 Percinta Elástica e Mola ensacada

Comprimento	290 cm
Profundidade	115 cm
Retrátil aberto	170 cm
Braço	25 cm
Assento	120 cm
Altura	105 cm

MODELO

8060







1

Encosto reclinável  
com fibra de silicone

2

Assento retrátil com mola e  
espuma D26

3

Madeira  
eucalipto

**MODELO  
8060**

Visão Lateral

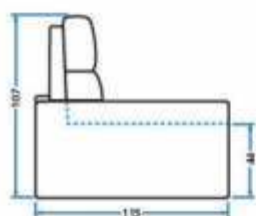

Visão Frontal

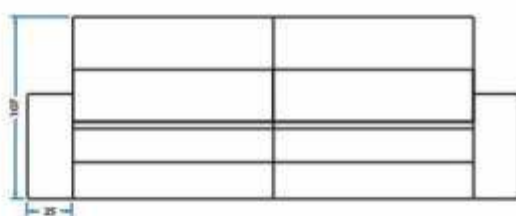

Visão Superior (Retrátil Fechado)

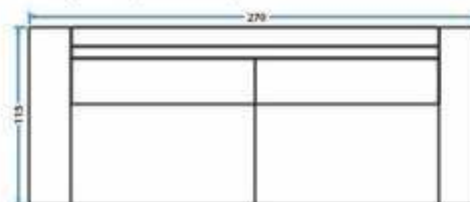

Visão Superior (Retrátil Aberto)

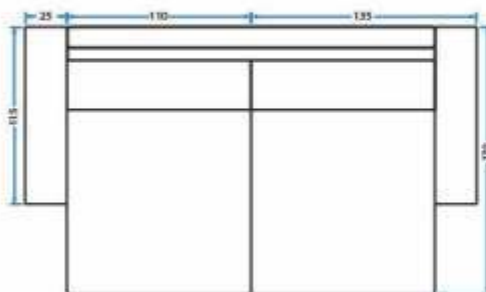

Comprimento	270 cm
Prof. retrátil fechado	115 cm
Prof. retrátil aberto	170 cm
Altura	107 cm
Largura do braço	25 cm
Módulo com braço	135 cm
Módulo sem braço	110 cm

MODELO

9015 MOLA ENSACADA





MODELO  
9015

1

Encosto reclinável e desmontável com fibra selecionada

2

Assento retrátil com mola ensacada e persinta elástica

3

Madeira Eucalipto



mola ensacada

Comprimento	290 cm
Profundidade	115 cm
Retrátil aberto	170 cm
Braço	25 cm
Assento	120 cm
Altura	109 cm

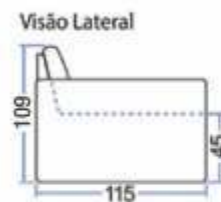
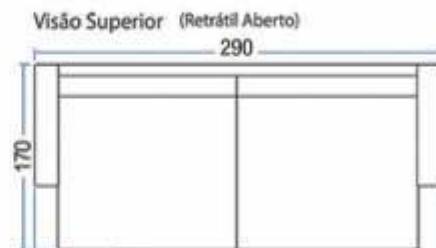
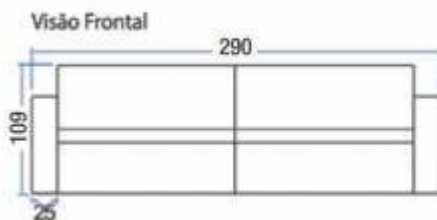



MODELO

9025 MOLA ENSACADA





MODELO  
9025



costura dupla



mola ensacada

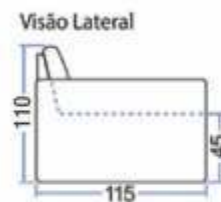
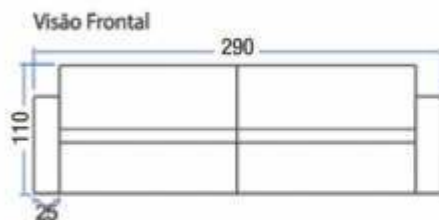

- 1 Encosto reclinável e desmontável com fibra selecionada
- 2 Assento retrátil com mola ensacada e persinta elástica
- 3 Madeira Eucalipto

Comprimento	290 cm
Profundidade	115 cm
Retrátil aberto	175 cm
Braço	25 cm
Assento	120 cm
Altura	110 cm



MODELO

9035







MODELO  
9035

- 1 Almofada solta
- 2 Assento com mola
- 3 Sofá cama

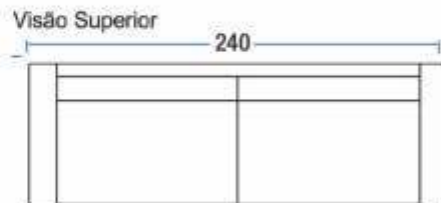
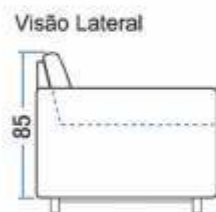
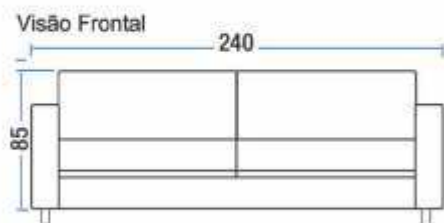

Comprimento	240 cm
Br	5 cm
Modulo sem braço	115 cm
Altura	85 cm
Retrátil aberto	150 cm
Retrátil fechado	110 cm
Caixa traseira	7 cm

MODELO

9045





MODELO  
9045

- 1 Madeira eucalipto de reflorestamento
- 2 Retrátil e reclinável
- 3 Mola

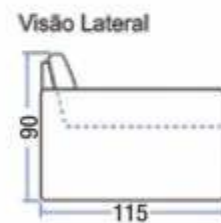
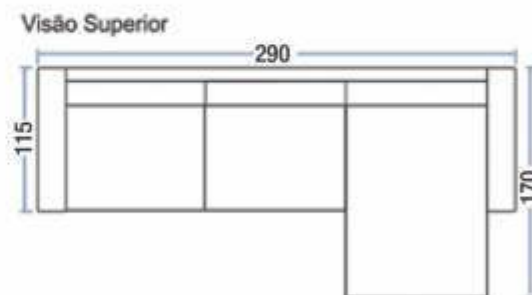
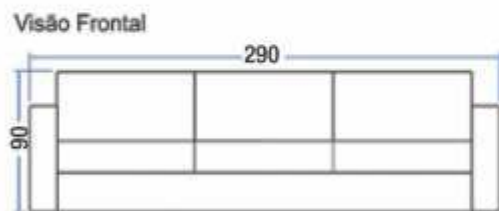

Comprimento	290 cm
Br	25 cm
Modulo sem braço	120 cm
Retrátil aberto	170 cm
Retrátil fechado	115 cm
Altura	1m



MODELO

9055





MODELO  
9055

- 1 Reclinável com espuma soft no encosto
- 2 Retrátil
- 3 Pillow duplo de espuma e mola.

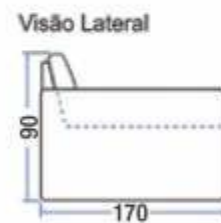
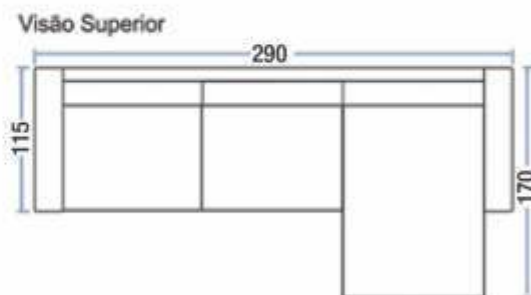
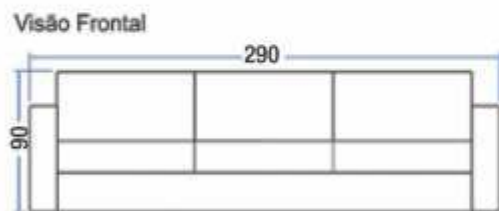

Comprimento	290 cm
Br	25 cm
Modulo sem braço	120 cm
Retrátil aberto	170 cm
Retrátil fechado	115 cm
Altura	90 cm



MODELO

9065







MODELO  
9065

- 1 Almofada solta
- 2 Retrátil e reclinável
- 3 Mola

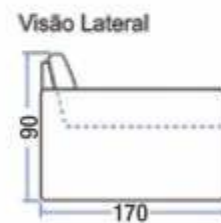
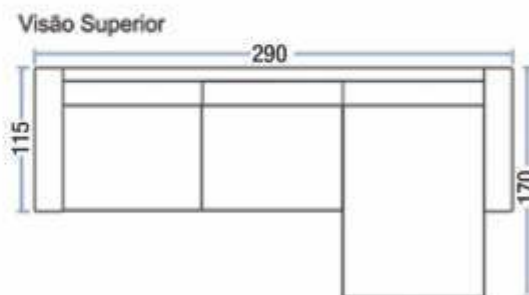
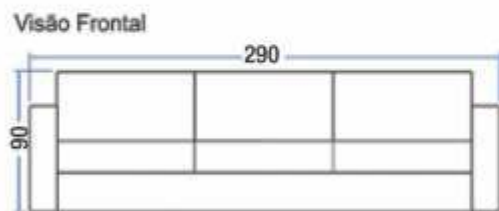

Comprimento	290 cm
Br	25 cm
Modulo sem braço	120 cm
Retrátil aberto	170 cm
Retrátil fechado	115 cm
Altura	90 cm

MODELO

ASA 01





Obs. Neses produtos fazemos todas as medidas.  
Porém não alteramos as medidas dos braços



1

Almofadas soltas

2

Assento com  
espuma D26

3

Madeira de Eucalipto

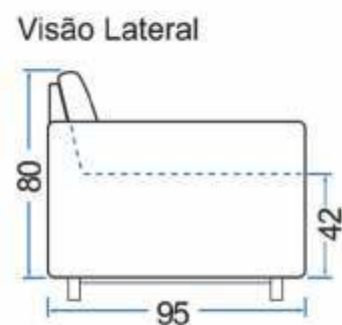
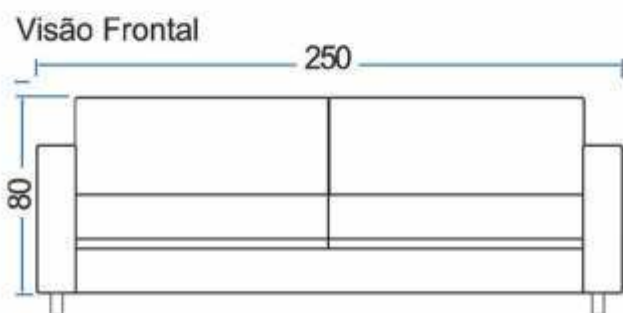

MODELO  
ASA 01

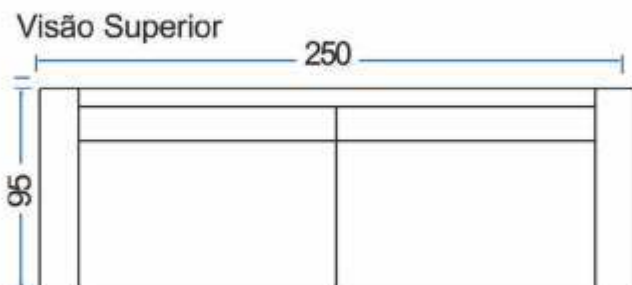

Comprimento	250 cm
Profundidade	95 cm
Altura do encosto do chão	80 cm
Altura do assento do chão	42 cm
Altura do braço do chão	60 cm
Altura do pé	10 cm
Largura do braço	17 cm

Produto assinado pelo Escritório  
Asa Design



MODELO

ASA 02





*Obs. Neses produtos fazemos todas as medidas.  
Porém não alteramos as medidas dos braços*

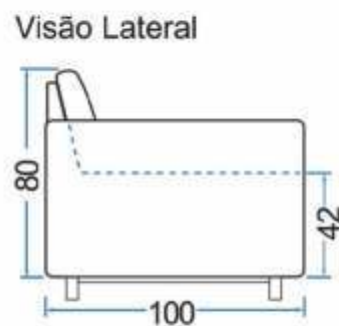
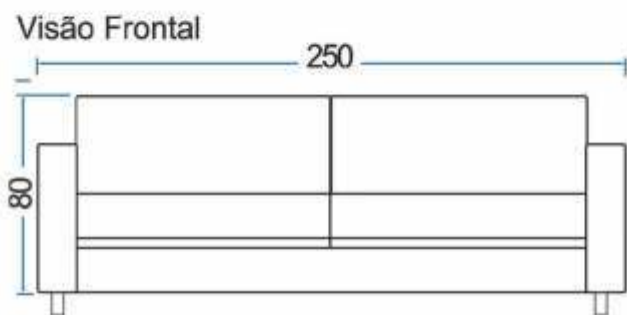

MODELO  
ASA 02

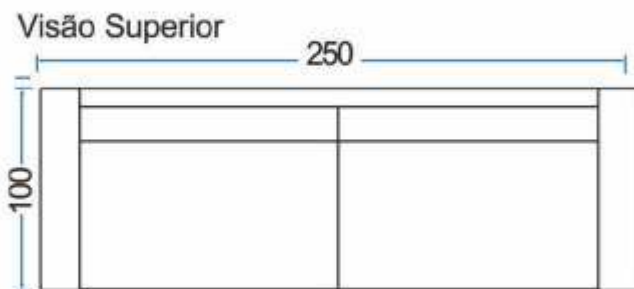

- 1 Almofadas soltas
- 2 Assento com espuma D26
- 3 Madeira de Eucalipto

Comprimento	250 cm
Profundidade	100 cm
Altura do encosto do chão	80 cm
Altura do assento do chão	42 cm
Altura do braço do chão	62 cm
Altura do pé	12 cm
Largura do braço	70 cm

Produto assinado pelo Escritório  
Asa Design



MODELO

ASA 3

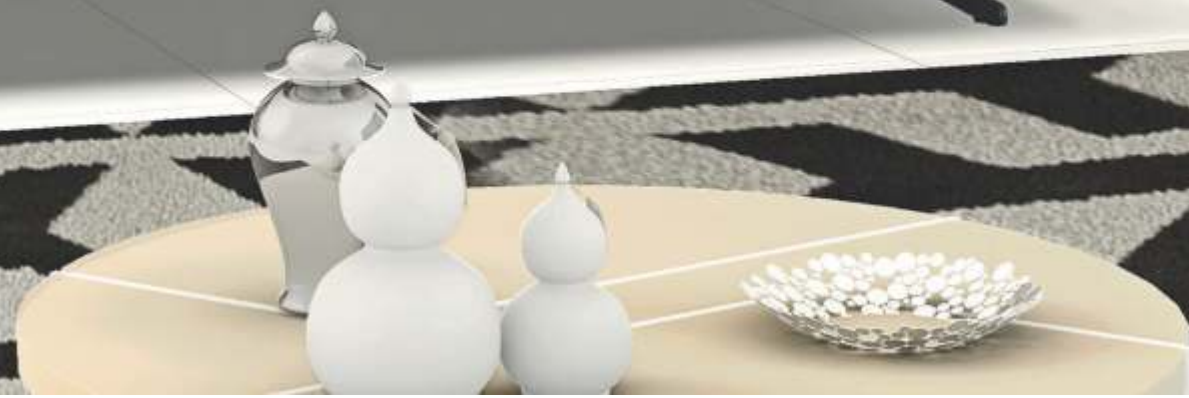





*Obs. Neses produtos fazemos todas as medidas.  
Porém não alteramos as medidas dos braços*

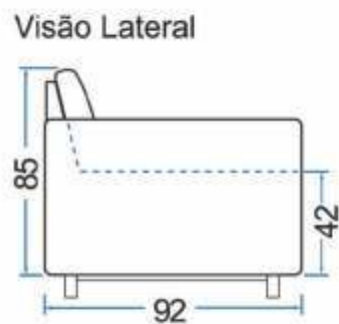
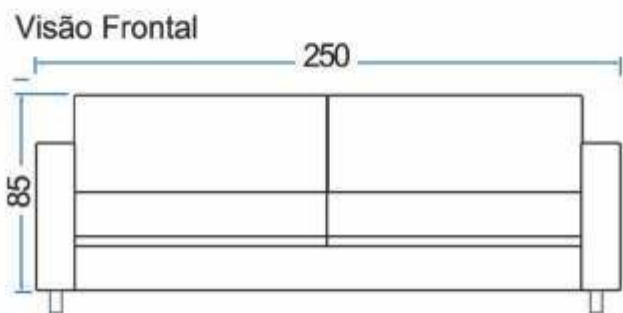

MODELO  
ASA 3

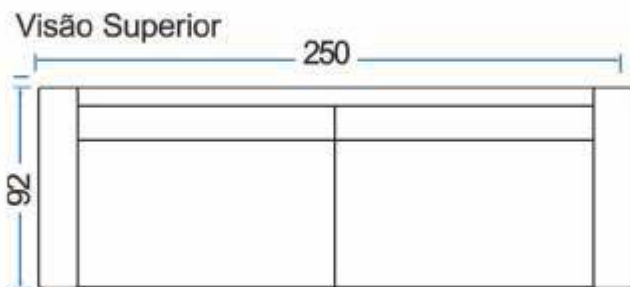

1

Almofadas soltas

2

Assento com  
espuma D26

3

Madeira de Eucalipto

Comprimento	250 cm
Profundidade	92 cm
Altura do encosto do chão	85 cm
Altura do assento do chão	42 cm
Altura do braço do chão	67 cm
Altura do pé	12 cm
Largura do braço	13 cm

Produto assinado pelo Escritório  
Asa Design

MODELO

ASA 4





1

Almofadas soltas

2

Assento com espuma D26

3

Madeira de Eucalipto

### MODELO ASA 4

Visão Frontal

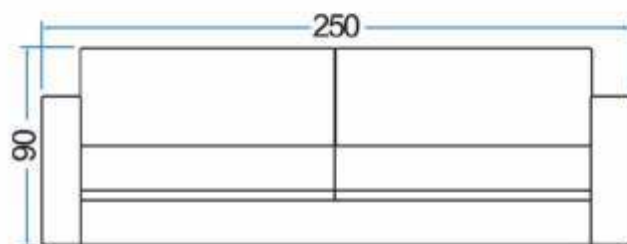

Visão Lateral

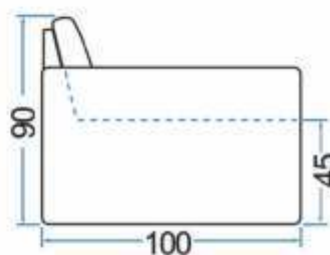

Visão Superior

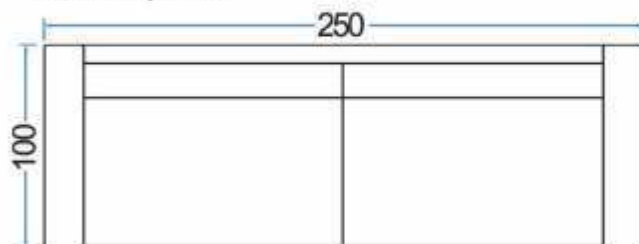

Comprimento	.	250 cm
Altura	.	90 cm
Profundidade	.	100 cm
Braço superior	.	15 cm
Braço inferior	.	8 cm

Produto assinado pelo Escritório  
Asa Design



MODELO

ASA 05





Obs. Neses produtos fazemos todas as medidas.  
Porém não alteramos as medidas dos braços



1

Aimofadas soltas  
com espuma D 26 soft

2

Assento com  
espuma D26

3

Madeira de Eucalipto

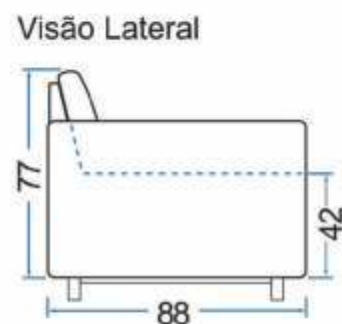
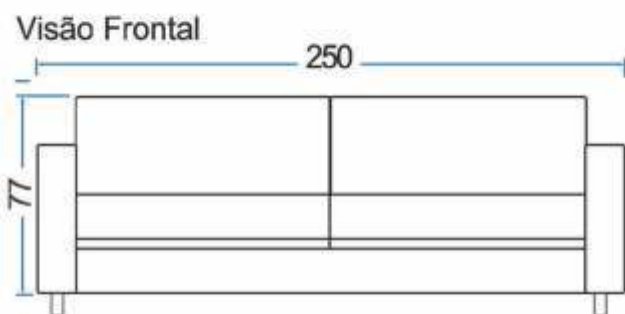

MODELO  
ASA 05

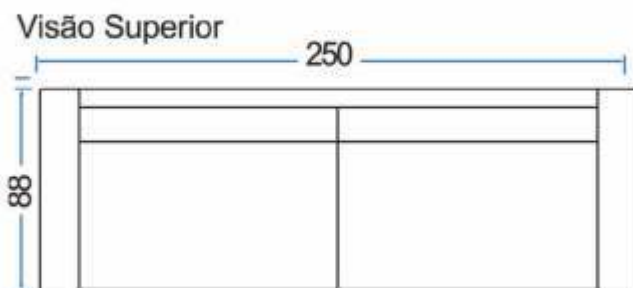

Comprimento	250 cm
Profundidade	88 cm
Altura do encosto do chão	77 cm
Altura do assento do chão	42 cm
Altura do braço do chão	50 cm
Altura do pé	13 cm
Largura do braço	18 cm

Produto assinado pelo Escritório  
Asa Design



MODELO

1007







- 1 Encosto espuma soft, almofadas decorativas com fibra siliconada
- 2 Percina elástica e mola
- 3 Madeira de eucalipto, Pés de ferro

MODELO  
1007

Visão Frontal

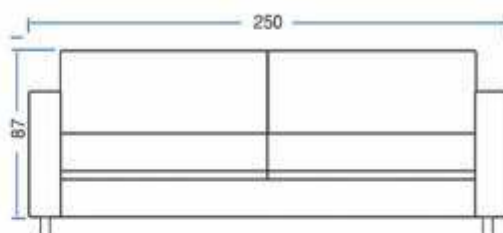

Visão Lateral

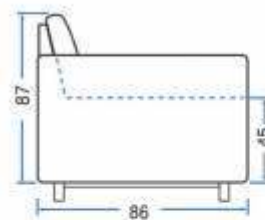

Comprimento	.	250 cm
Profundidade	.	86 cm
Altura do encosto do chão	.	87 cm
Altura do assento do chão	.	45 cm
Altura do pé	.	15 cm
Largura do braço	.	5 cm

MODELO

1020





MODELO  
1020

1

Almofadas soltas de espuma soft

2

Pés em ferro  
Mola espiral

3

Madeira eucalipto

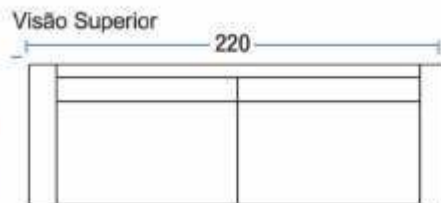
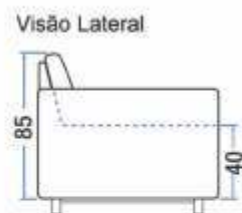
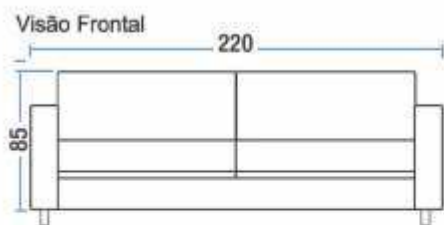

Comprimento	2,20 cm
Braço	8 cm
Modulo sem braço	1 m
Altura	0,85 cm
Altura do assento	45cm
Altura	85 cm



MODELO

1030





MODELO  
1030

- 1 Almofoadas soltas de espuma soft
- 2 Pés em madeira
- 3 Mola espiral

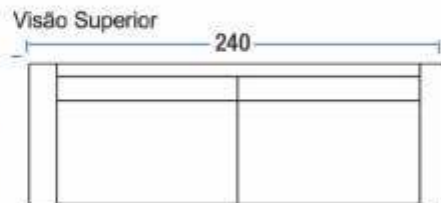
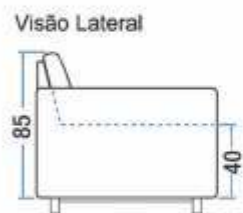
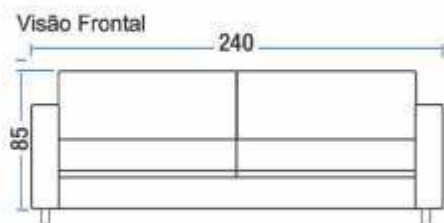

Comprimento	240cm
Br parte de cima	16 cm
Br parte de baixo	20 cm
Altura do assento	45cm
Altura	85 cm



MODELO

4000







1

Sofá curvo, acompanha 4 almofadas decorativas com fibra siliconada

2

Encosto de espuma

3

Madeira de eucalipto

## MODELO 4000

Visão Frontal

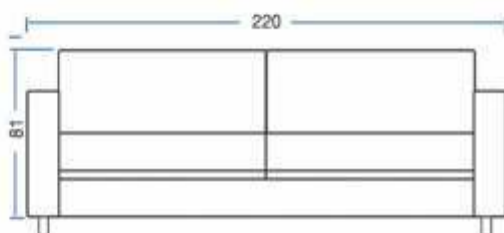

Visão Lateral

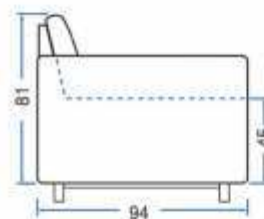

Comprimento	220 cm
Profundidade maior	94 cm
Profundidade menor	87 cm
Altura	81 cm
Altura do assento	45 cm
Altura do pé	15 cm

MODELO

7018





1

Encosto almofadas soltas de fibra siliconada

2

Percinta elástica e mola espiral

3

Detalhe preto pode ser feito em qualquer tecido ou pode ser tirado  
Mesa (mel ou tabaco)

MODELO  
**7018**

Visão Frontal

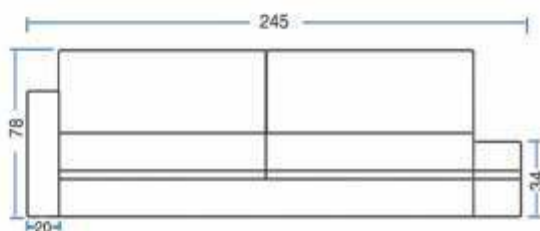

Visão Superior

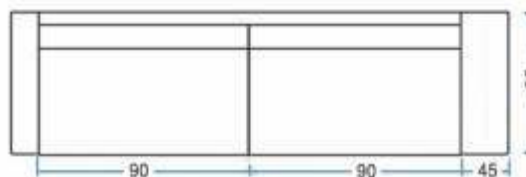

Visão Lateral

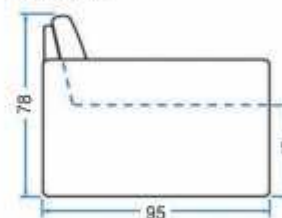

Comprimento	·	245 cm
Profundidade	·	95 cm
Altura	·	78 cm
Altura da mesa	·	34 cm
Comp. da mesa	·	45 cm
Prof. da mesa	·	95 cm
Largura do braço	·	20 cm



MODELO

3035





MODELO  
3035

- 1 Almofadas soltas de fibra siliconada
- 2 Assento com espuma D26
- 3 Madeira eucalipto

Comprimento	.	220 cm
Profundidade	.	90 cm
Altura	.	85 cm
Altura do assento	.	45 cm
Largura do braço	.	9 cm

Visão Frontal

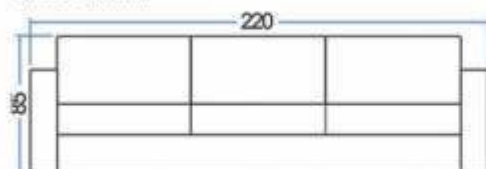

Visão Superior

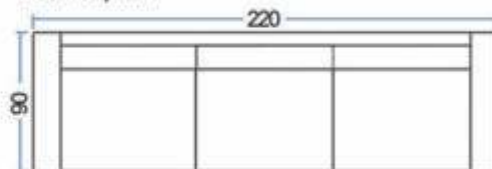

Visão Lateral

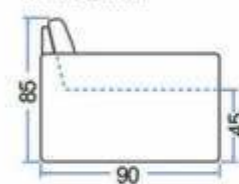



MODELO

3080







MODELO  
3080

- 1 Almofadas fixas com fibra siliconada
- 2 Assento com espuma D26
- 3 Madeira eucalipto

Comprimento	.	250 cm
Profundidade	.	100 cm
Altura	.	83 cm
Altura do assento	.	44 cm
Largura do braço	.	0 cm

Visão Frontal

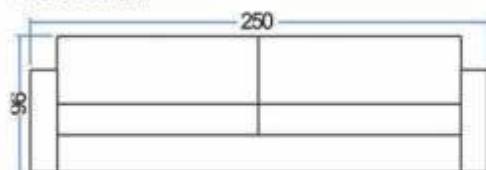

Visão Superior



Visão Lateral

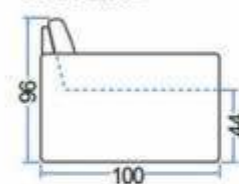

MODELO

4045





MODELO  
4045

- 1 Encosto solto com fibra siliconada
- 2 Assento fixo com mola e percinta
- 3 Madeira eucalipto

Visão Frontal

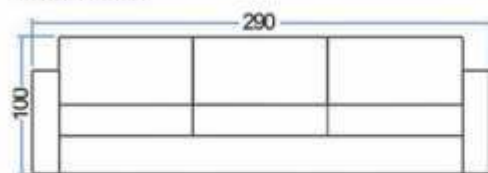

Visão Superior

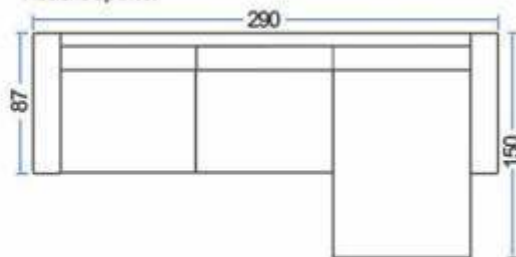

Visão Lateral

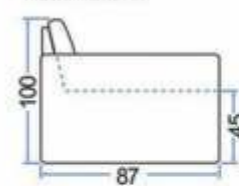

Comprimento	·	290 cm
Prof. assento	·	87 cm
Prof. Chassi	·	150 cm
Altura	·	100 cm
Altura do assento	·	45 cm
Largura do braço	·	25 cm



MODELO

6085





1

Almofadas fixa

2

Assento com  
espuma D26

3

Madeira de Eucalipto

Visão Frontal

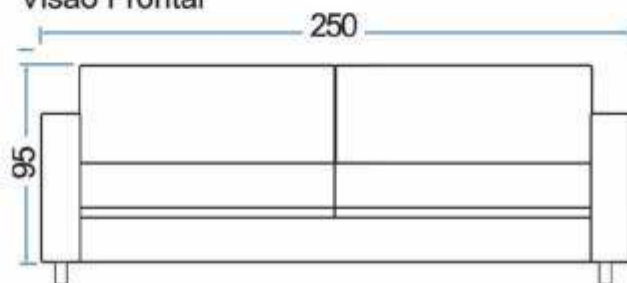

Visão Lateral

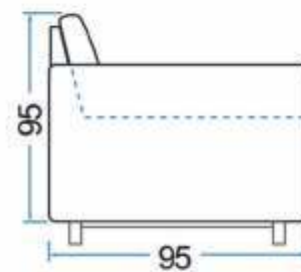

MODELO  
6085

Visão Superior

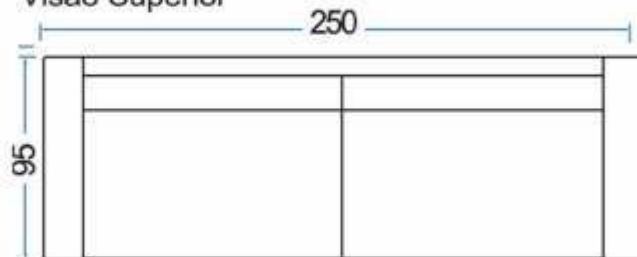

Comprimento	.	250 cm
Altura	.	95 cm
Profundidade	.	95 cm
Braço	.	25 cm



MODELO

7085







MODELO  
7085

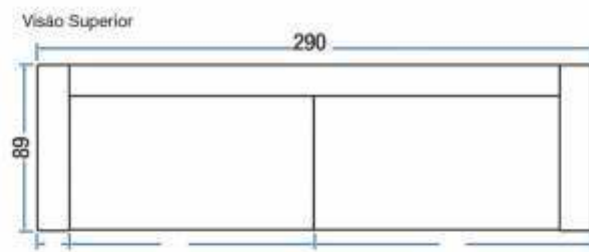
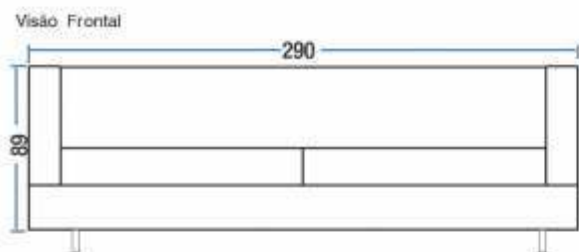

Visão Lateral

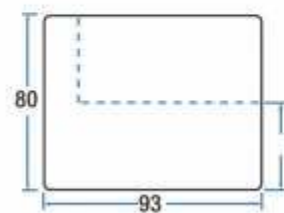

- 1 Madeira de eucalipto
- 2 Persinta + mola
- 3 Pés de ferro preto  
Acompanha 4 almofadas

Comprimento	290 cm
Profundidade	93 cm
Altura	89 cm
Assento	110 cm
Braço	10 cm
Altura do pé	18 cm

MODELO

7095





MODELO  
7095

1

Almofadas soltas  
com espuma soft

2

Madeira, cores mel  
e imbuia

3

Percinta Elástica e  
mola espiral

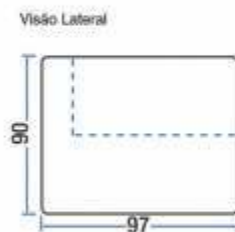
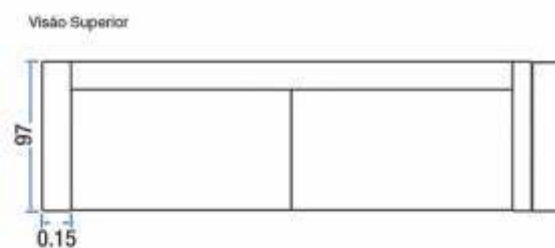
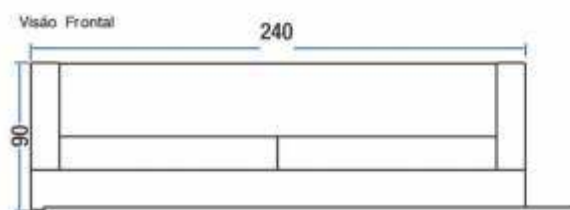

Comprimento	240 cm
Profundidade	97 cm
Altura	90 cm
Braço	15 cm



MODELO

8015





MODELO  
8015

1

Almofadas soltas  
com espuma soft

2

Assento com mola com espuma D26

3

Madeira  
eucalipto

Visão Frontal

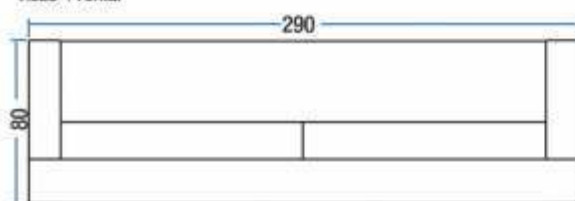

Visão Superior

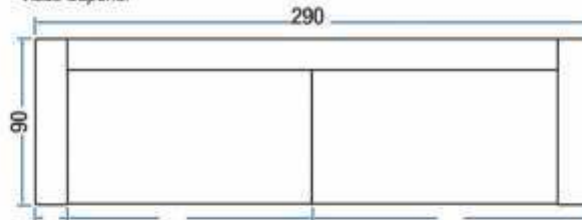

Visão Lateral

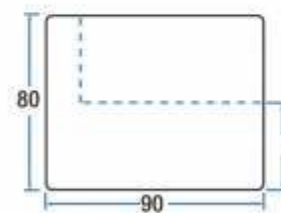

Comprimento	290 cm
Profundidade	90 cm
Altura	80 cm
Altura do assento	44 cm
Braço sem espuma	10 cm
Braço com espuma	20 cm



MODELO

8045







MODELO  
8045

1

Almofadas soltas de espuma soft

2

Pés em ferro

3

Madeira eucalipto

Visão Frontal

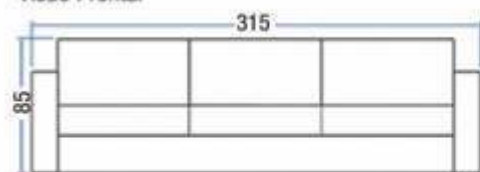

Visão Superior

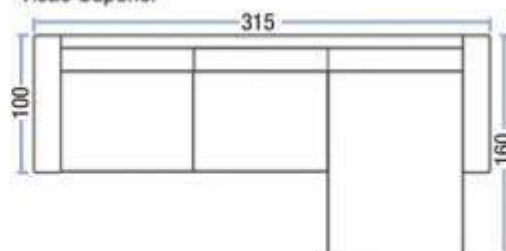

Visão Lateral

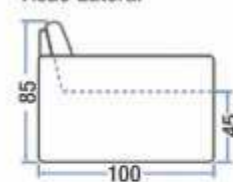

Comprimento	315 cm
Largura do braço	10 cm
Chaise sem braço	105 cm
Prof. Chaise	160 cm
Comprimento 2 L com braço	196 cm
Profundidade	100 cm
Altura	85 cm

Mesa 95 x 45 cm  
Altura 40 cm

MODELO

8050





MODELO  
8050

1

Almofadas soltas de fibra siliconada

2

Percinta elástica com espuma D26

3

Madeira eucalipto

Visão Frontal

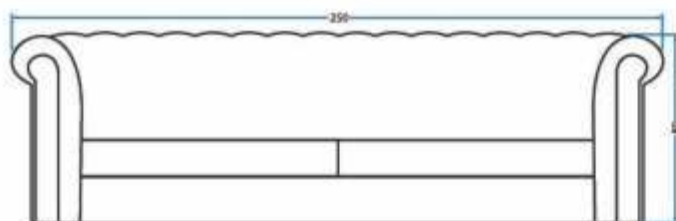

Visão Superior

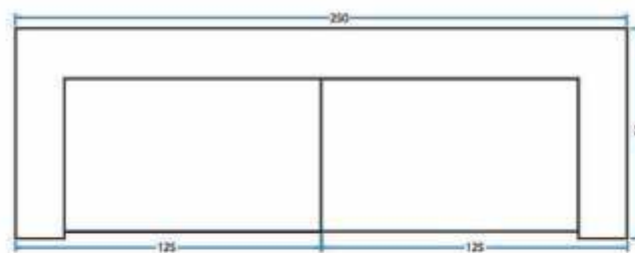

Visão Lateral

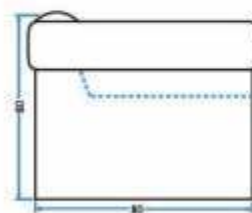

Comprimento	.	250 cm
Altura	.	80 cm
Profundidade	.	80 cm



MODELO

8070





MODELO  
8070

Visão Frontal

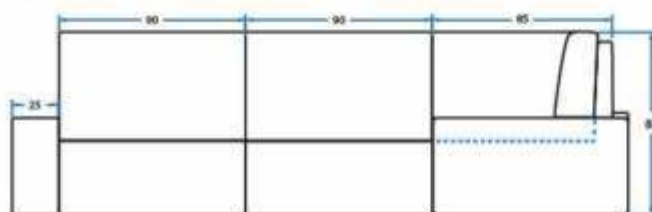

Visão Lateral

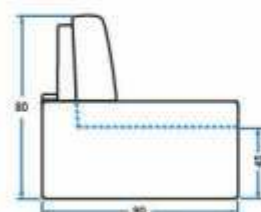

Visão Superior

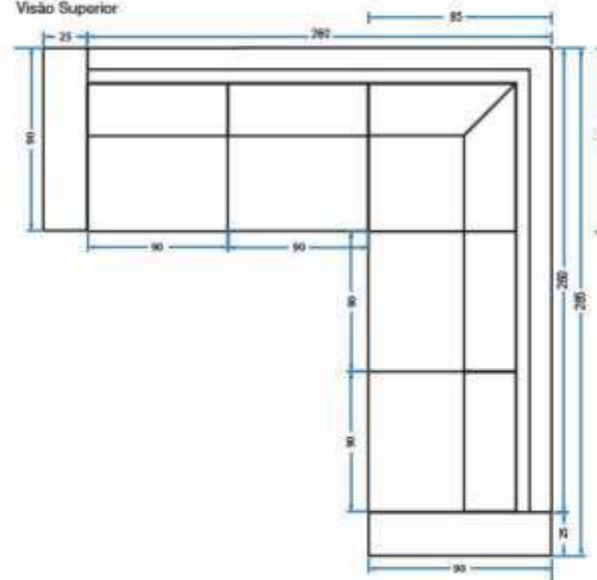

1

Almofadas soltas de fibra siliconada

2

Assento solto com espuma D26

3

Madeira eucalipto

Comprimento	·	285 x 285 cm
Profundidade	·	90 cm
Altura	·	80 cm
Altura do assento	·	45 cm
Largura do braço	·	20 cm
Módulo	·	90 cm



MODELO

9075







MODELO  
9075

- 1 Base MDF mel ou tabaco
- 2 Mola/acompanha almofadas decorativas
- 3 Almofadas soltas

Comprimento	220 cm
Br	10 cm
Modulo sem braço	100 cm
Altura	90 cm

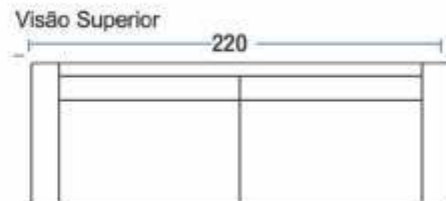
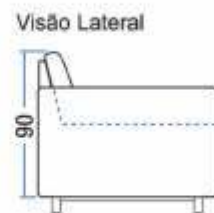
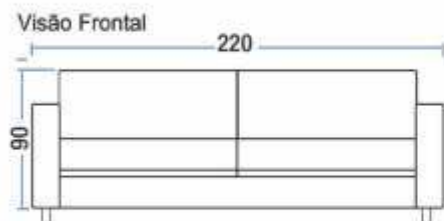

MODELO

9085





MODELO  
9085

- 1 Mola
- 2 Almofadas soltas de fibra siliconada
- 3 Madeira Eucalipto

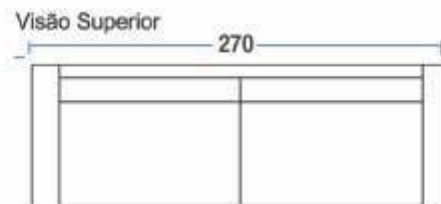
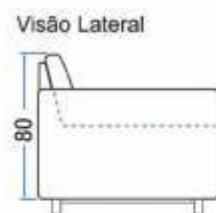
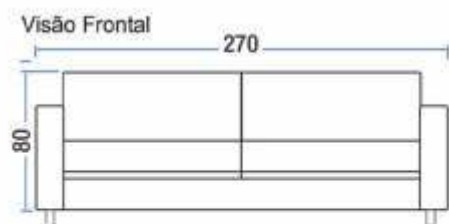

Comprimento	270 cm
Br	10 cm
Modulo sem braço	125 cm
Altura	80 cm



MODELO

9095

LARD  
VORK  
*beauty*  
VALENT  
*when*  
ALEN  
*loopy*  
WOK  
HARI





MODELO  
9095

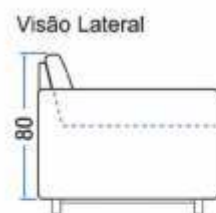
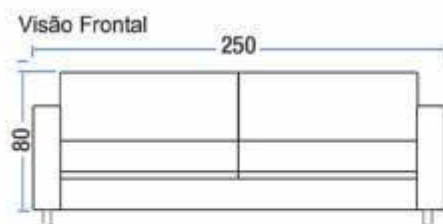

1

Almofada solta de espuma soft

2

Pés de ferro/acompanha almofadas decorativas

3

Mola

Comprimento	250 cm
Br	20 cm
Modulo sem braço	105 cm
Altura	80 cm
Profundidade	95 cm



MODELO

1040







MODELO  
1040

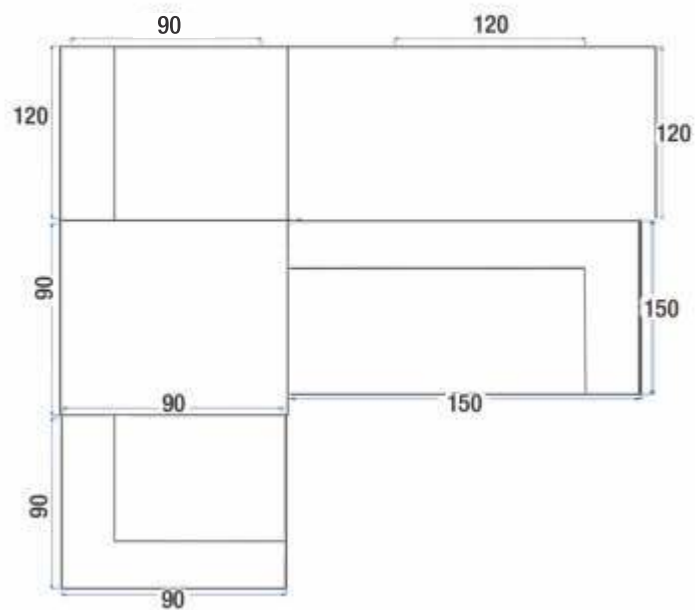

1

Assento com espuma  
+ manta siliconada.

2

Modulado/madeira  
eucalipto de reflorestamento

3

Mola espiral

Puff maior	1,20 x 1,20
Puff menor	0,90 x 0,90
Modulo com encosto	90 m
Modulo com Br e encosto maior	1,50 m
Modulo com Br e encosto menor	1,20 m
Altura	78 cm
Br e encosto	30 cm
Altura do assento	45 cm

MODELO

4005





1

Encosto fixo  
com fibra siliconada

2

Assento retrátil com mola  
com espuma D26

3

Madeira  
eucalipto

MODELO  
4005

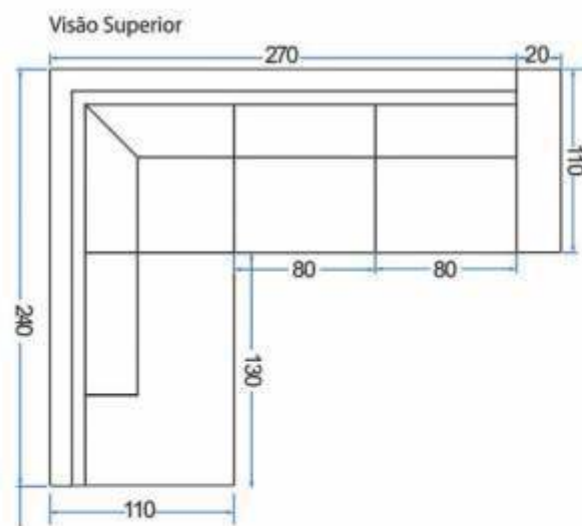
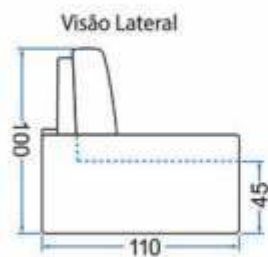
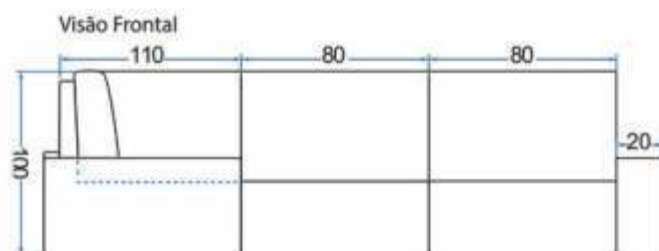

Comprimento	.	290 cm
Prof. retrátil fechado	.	110 cm
Prof. retrátil aberto	.	150 cm
Altura	.	100 cm
Altura do assento	.	45 cm
Largura do braço	.	20 cm



MODELO

5005





MODELO  
**5005**

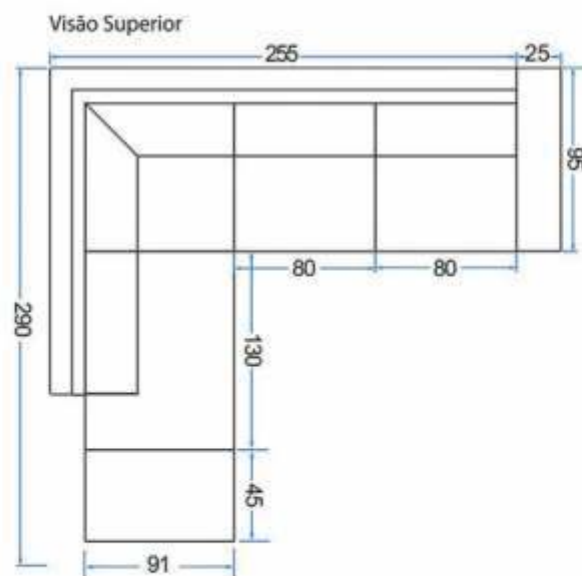
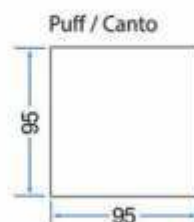
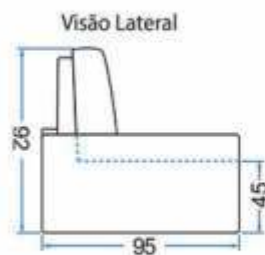
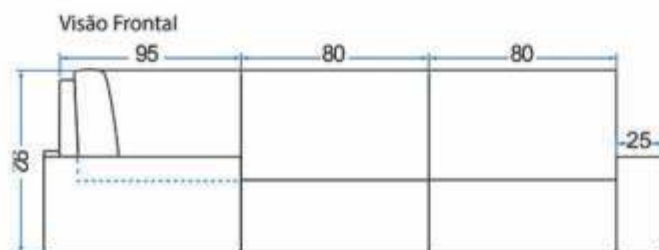

1

Encosto reclinável  
com fibra siliconada

2

Assento retrátil com mola  
com espuma D26

3

Madeira  
eucalipto

Comprimento	280 cm
Comprimento Chaise	290 cm
Altura	92 cm
Altura do assento	45 cm
Largura do braço	25 cm
Tamanho MDF	45 x 91 cm

Painel em MDF disponível nas cores:  
Tabaco e Mel



MODELO

6045







1

Encosto almofadas soltas

2

Assento fixo com mola

3

Madeira de Eucalipto

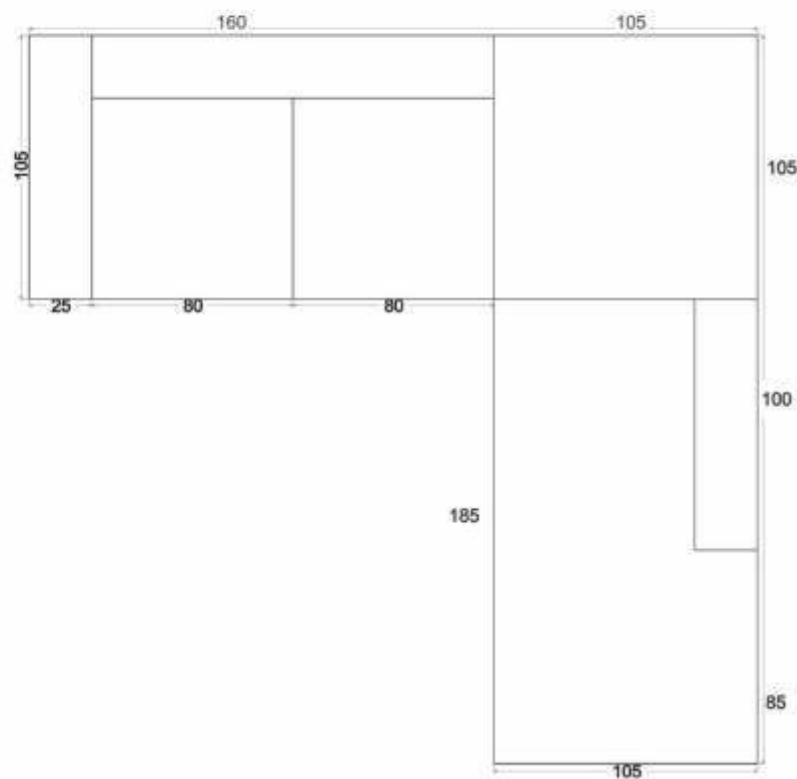

MODELO  
6045

Visão Lateral

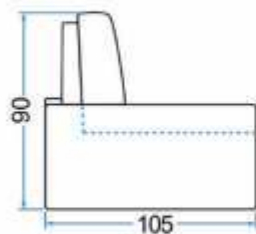

Comprimento 1	290 cm
Comprimento 2	290 cm
Altura	90 cm
Profundidade	105 cm
Braço	25 cm

MODELO

6055





1

Almofadas soltas

2

Assento fixo com mola

3

Madeira de Eucalipto

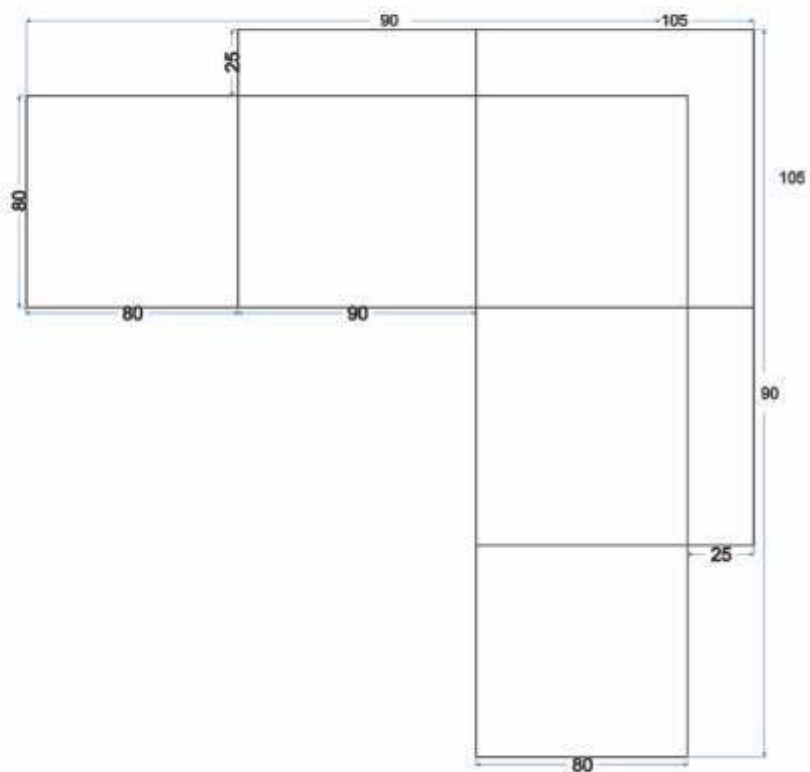

## MODELO 6055

Comprimento 1	•	275 cm
Comprimento 2	•	275 cm
Altura	•	85 cm
Profundidade	•	105 cm
Braço	•	25 cm



MODELO

8005





MODELO  
8005

Visão Frontal

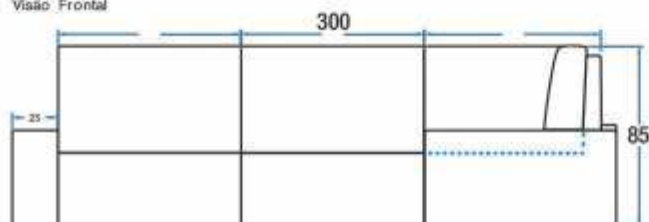

Visão Lateral

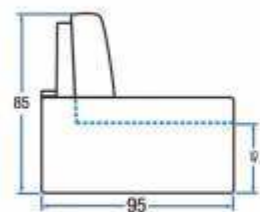

Visão Superior

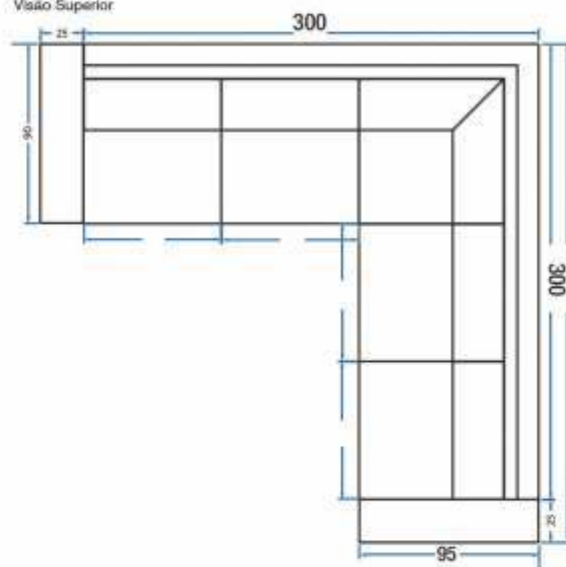

1

Encosto fixo de espuma soft

2

Assento espuma D26 fixo

3

Pés de ferro

Comprimento 300 x 300 cm  
Profundidade 95 cm  
Altura 85 cm



MODELO

8040







MODELO  
**8040**

1

Encosto fixo e  
desmontável de fibra siliconada

2

Assento com molas, percinta elástica  
e espuma D 26

3

Madeira  
eucalipto

Visão Frontal



Visão Lateral (Módulo)

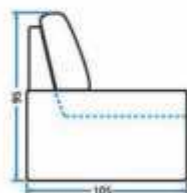

Visão Superior (Retrátil Aberto)

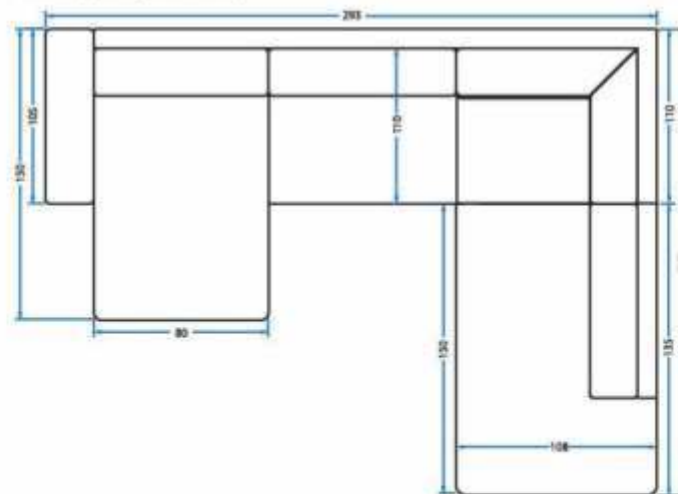

Comprimento	293 x 240 cm
Prof. retrátil fechado	110 cm
Prof. retrátil aberto	150 cm
Altura	95 cm
Largura do braço	25 cm
Comprimento da chaise	135 cm
Canto	110 cm

MODELO

3070





1

Encosto reclinável  
com fibra siliconada

2

Assento retrátil com mola  
com espuma D26

3

Madeira  
eucalipto

MODELO  
3070  
SOFÁ CAMA

Comprimento	180 cm
Assento	140 cm
Profundidade	90 cm
Encosto	50 cm
Assento frente	70 cm
Sofá deitado	193 cm
Altura	90 cm
Largura do braço	20 cm

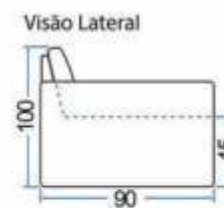
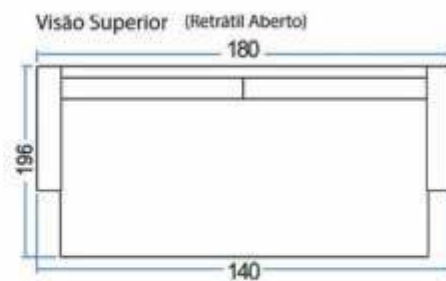
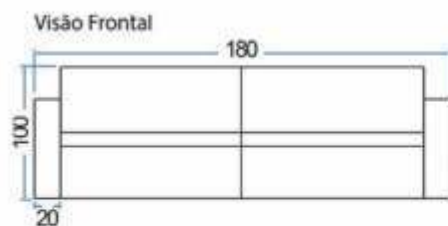



MODELO

7045





1

Encosto reclinável e  
almofadas soltas de fibra siliconada

2

Assento retrátil  
Espuma D26 - Madeira eucalipto

3

Percinta Elástica

MODELO  
**7045**  
SOFÁ CAMA

Visão Frontal (2 Lugares)

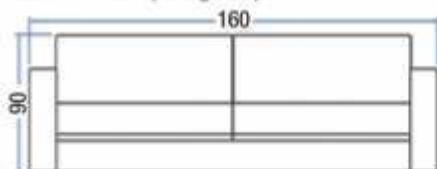

Visão Lateral

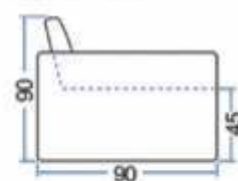

Visão Superior (2 Lugares)

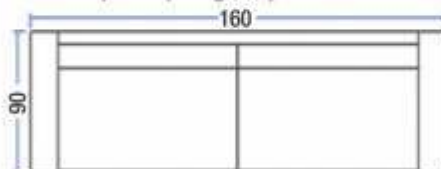

Visão Lateral



Comprimento	160 cm
Assento	140 cm
Profundidade	90 cm
Encosto	50 cm
Assento frente	70 cm
Sofá deitado	193 cm
Altura	90 cm
Largura do braço	10 cm

POLTRONA  
*Valentina*



Altura da poltrona: 90 cm;  
Profundidade: 80 cm;  
Largura: 74 cm;



POLTRONA

*Emilia*



Altura da poltrona: 85 cm;  
Profundidade: 92 cm;  
Largura: 110 cm;

POLTRONA

*Angel*



Altura da poltrona: 80 cm;  
Profundidade: 95 cm;  
Largura: 110 cm;

POLTRONA

*Livia*



Altura da poltrona: 89 cm;  
Profundidade: 93 cm;  
Largura: 110 cm;



POLTRONA

*Ellen*



Altura da poltrona: 90 cm;  
Profundidade: 75 cm;  
Largura: 80 cm;

POLTRONA

*Fani*



Altura da poltrona: 84 cm;  
Profundidade: 50 cm;  
Largura: 60 cm;

POLTRONA

*Betina*



BASE DE MDF MEL OU TABACO

Altura da poltrona: 84 cm;  
Profundidade: 81 cm;  
Largura: 118 cm;



POLTRONA

*Argata*



Altura da poltrona: 80 cm;  
Profundidade: 80 cm;  
Largura: 75 cm;

POLTRONA

*Adèle*



BASE DE MDF MEL OU TABACO

Altura da poltrona: 70 cm;  
Profundidade: 85 cm;  
Largura: 80 cm;

POLTRONA

*Pietà*



Altura da poltrona: 90 cm;  
Profundidade: 78 cm;  
Largura: 77 cm;



POLTRONA  
*Costela*



**Poltrona Costela**  
Altura da poltrona: 78 cm;  
Profundidade: 88 cm;  
Largura: 67 cm;

**Puff Costela**  
Altura da poltrona: 42 cm;  
Profundidade: 58 cm;  
Largura: 65 cm;

POLTRONA

*Elisa*



Altura da poltrona: 87 cm;  
Profundidade: 80 cm;  
Largura: 70 cm;